

# Evonik Solutions for Battery Electric Vehicles

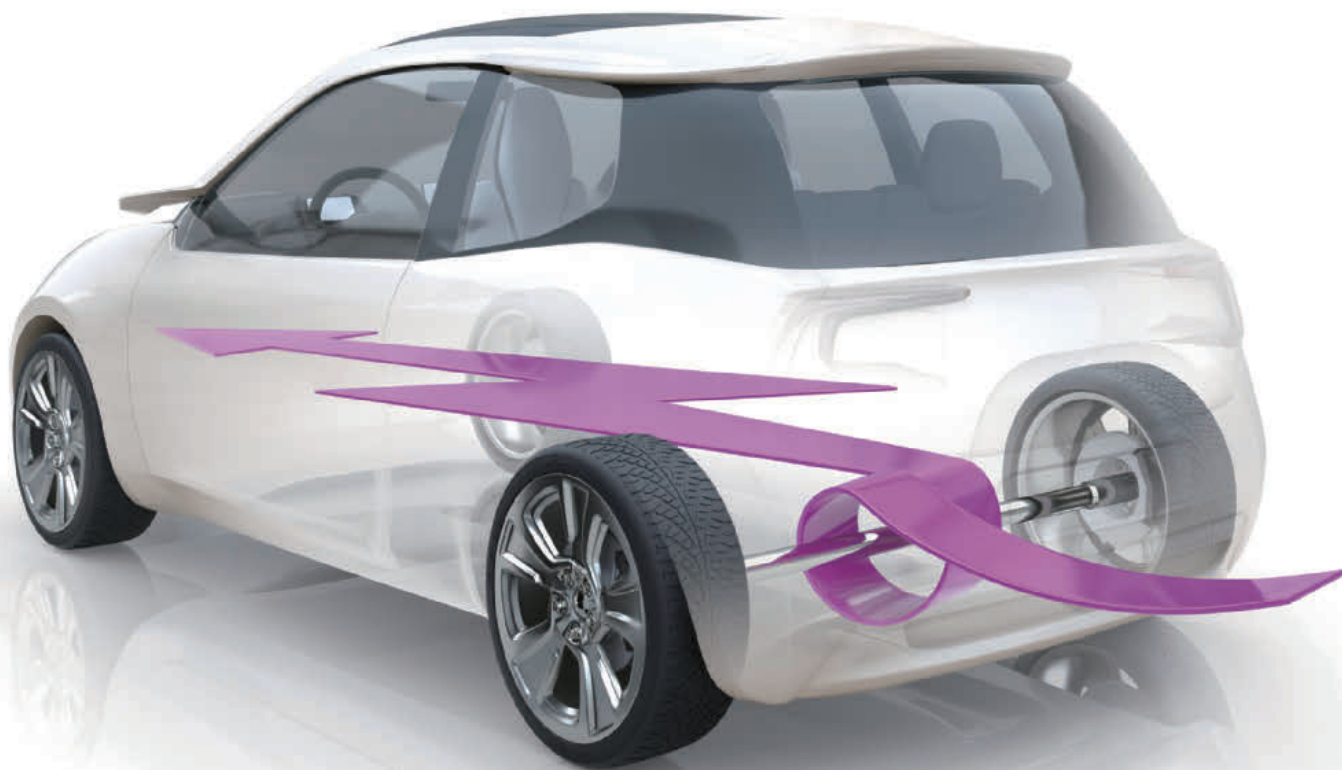

# LEADING BEYOND CHEMISTRY

TO IMPROVE LIFE,  
TODAY AND TOMORROW

Evonik is one of the world leaders in specialty chemicals. The company is active in more than 100 countries around the world. Evonik goes far beyond chemistry to create innovative, profitable and sustainable solutions for customers. More than 32,000 employees work together for a common purpose: We want to improve life, day by day.

**Innovate mobility —  
we provide  
the chemistry**

**We drive new mobility.**

**We boost efficiency.**

**We save weight.**

**We create surfaces.**

For more product information, please scan QR code to install EvonikAutomotive APP.



iPhone



Android

# Evonik makes the electric vehicle batteries safer and long-living

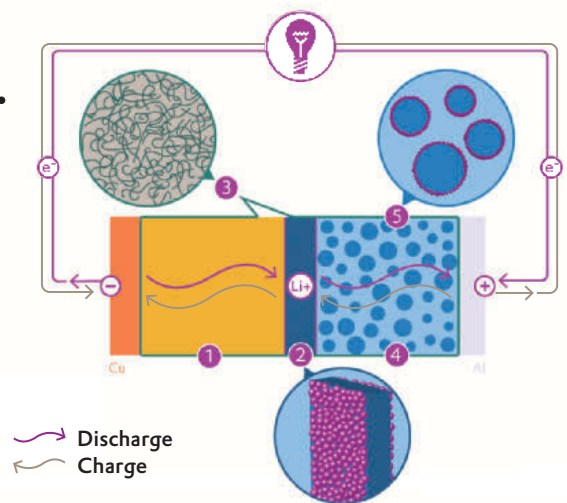

Photo credit: Adobe stock/Chesky



## Our solutions for EV battery packs

- 1 **AEROXIDE® fumed metal oxides**  
improve performance, life-time, and safety of Li-ion battery cells.
- 2 **TEGO® Surten E**  
These process enablers help improving the production of Li-ion batteries achieving better electrical performance and lower overall costs.
- 3 **VESTALITE® S, the new curing agent**  
allows using optimized epoxy SMC technology for structural lightweight applications.
- 4 **VESTAMID® PA12**  
the UL94 flame retardant polymer provides excellent high-voltage insulation properties for power busbar applications according to future safety requirements in EV.
- 5 **VESTAMID® PA12 tubing systems**  
contribute to an ideal thermal management of HV battery, e-motor, inverter and a well-tempered overall ambience of the car.
- 6 **Polymer VS and TEGOSIL®**  
Silicone raw materials and additives for thermal management.
- 7 **TEGOSTAB® and POLYCAT®**  
Silicone surfactants and amine catalysts to produce polyurethane froth foam for the protection of EV battery.



- 1 **Anode:**  
Carbon-based material with addition of silicon
- 2 **Separator:**  
microporous membrane coated with AEROXIDE®
- 3 **Gel polymer electrolyte:**  
immobilized by functional AEROXIDE®
- 4 **Cathode:**  
Mixed-oxide layer structure
- 5 **Cathode material**  
specially coated with AEROXIDE®

# Evonik provides various solutions for electric vehicle battery industry

Area	Products	Applications	Benefits	Page	
Battery Pack Structure	Battery Box	Curing agent	Epoxy SMC based battery enclosure	Easy processing, lightweight design and low emissions	5
Energy Storage	Cathode	Fumed metal oxides (Al <sub>2</sub> O <sub>3</sub> , TiO <sub>2</sub> )	Cathode Active Material (CAM) coating / doping	Protection of CAMs to enhance capacity retention / battery life	6 - 8
		Dispersant	Cathode slurry	Slurry viscosity reduction and stability improvement	
		Plasticizer	Cathode	Increasing cathode electrode layer flexibility	
	Anode	Silicon-based powders	Anode active material	Custom silicon-based anode materials with highly specific requirements	
		Dispersant	Anode slurry	Slurry viscosity reduction and stability improvement	
		Plasticizer	Anode	Increasing anode electrode layer flexibility	
	Separator	Fumed metal oxides (Al <sub>2</sub> O <sub>3</sub> )	Separator coating / incorporation	Improvement of thermal stability of separator	
		Low foaming, wetting agent	Ceramic slurry	Ceramic slurry surface tension reduction	
	Electrolyte	Fumed metal oxides (Al <sub>2</sub> O <sub>3</sub> )	Gel/polymer electrolyte	Realize semi-solid electrolyte for safety improvement	
	Power Management and Connectivity	PA12	power busbars	For perfect electric insulation	
Protection and Thermal Management	PA12	Cooling and heating line and connectors	Excellence performance together with production efficiency, lightweight and competitive system cost	10	
	Silicone and filler treatment portfolio	Gap filler and thermal interface material	High flexibility of silicone formulation, improved thermal performance	11	
	PU surfactant and catalyst	Cushioning and vibration absorption for battery packs	PU froth foam pad is both firm and compressible enough to extend the life of the battery	12	
	Battery Recycling	H <sub>2</sub> O <sub>2</sub>	Recycling of Ni, Co, Mn, Li	As the reducing agent to recover Li, Co, Ni, Mn in the leaching process	13
Contact us				14	

# Epoxy SMC based battery enclosure

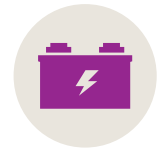

Battery Pack Structure

VESTALITE® S curing agent offers a styrene free, high performance solution for sheet molding compound (SMC) material when combined with a liquid epoxy resin.

Its unique properties make it suitable for automotive applications in large scale automated manufacturing (e.g. battery enclosure).

## CONSORTIUM APPROACH

Joint development of Evonik's Joint Venture Vestaro and further relevant partners along the electric vehicle battery value chain to achieve a holistic battery system solution.



## CONCEPT DEVELOPMENT

Multi-Material-Design to address all relevant functions and requirements of an integrated battery system

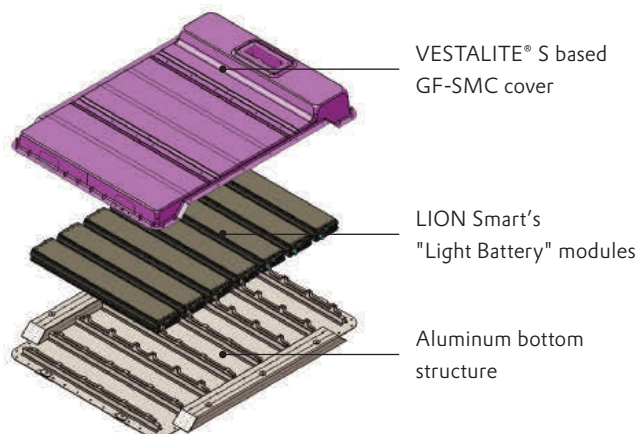

Crosslinkers

## HARDWARE DEMONSTRATOR

Epoxy SMC based on VESTALITE® S enables easy processing as the material shows excellent mold flow combined with fast curing.



## CONCEPT USP's & BENEFITS

### Efficient material usage

- Complex geometric shape for part reduction and optimal system packaging
- Multi-material usage to address different requirements like fire resistance or EMC
- Best in class mechanical performance of EP-SMC and local reinforcement materials enables low battery weight

### Functional integration

- Integration of module connection parts and further battery system relevant components (e.g. E/E-architecture)
- Integration of sealing and venting elements

### Cost effective design and manufacturing

- Modularity of battery system sizes due to specific tooling concept and adjustable "Light Battery" module sizes
- Outstanding energy and power density at low costs

### More solutions available:

#### Structural adhesives for Electric & Electronics

Ancamine® cyclo-aliphatic amine and Ancamide® polyamide curing agents offer a wide product range to modify T<sub>g</sub>, viscosity, latency, cure speed and toughness of 2K adhesives for ambient and heat cure applications for battery enclosures and structural applications in electric vehicles.



# AEROXIDE® fumed metal oxides as performance additives



Energy Storage

Product	Application
AEROXIDE® Alu 130, AEROXIDE® TiO <sub>2</sub> P 25	Protective dry coating for cathode active materials
AEROXIDE® Alu 65, AEROXIDE® Alu C AERODISP® Ready to use dispersions	High performance LIB separator as coating or filler
AEROXIDE®, Surface treated Alumina	Functional additive in new electrolyte formulations

AEROXIDE® fumed metal oxides are produced by flame hydrolysis (AEROSIL® process), the loose white powder consists of nano-structured aggregates. AEROXIDE® metal oxides are used as additives in Li-ion batteries to increase the **performance, life-time** and **safety** of the battery.

## Dry coating for cathode active materials

**AEROXIDE®** is used for cathode material surface coating to stabilize cathode active material particles and to avoid cracks during charge/discharge, resulting in an increased capacity retention and enhanced battery life.

SEM: Al mapping of AEROXIDE® coated NMC particles

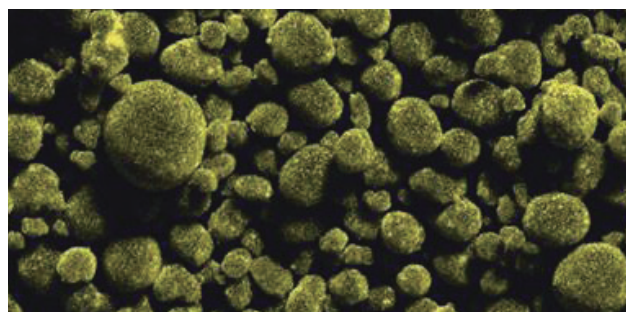

Cross section SEM imaging of cycled electrodes after 250 cycles

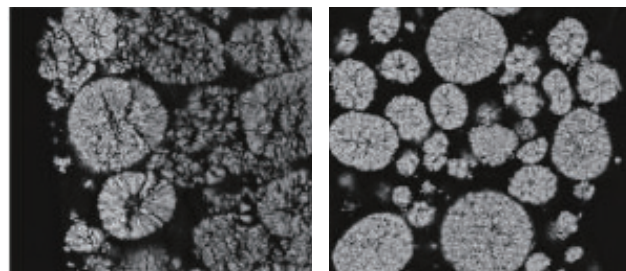

NMC-70, uncoated

NMC-70, **AEROXIDE®** coated

## High performance LIB separator as coating or filler

**AEROXIDE®** fumed alumina enables the use of ultra-thin ( $\leq 1 \mu\text{m}$ ), homogeneous ceramic coatings or is applied as ceramic filler inside the membrane, resulting in improvement of thermal stability of separator.

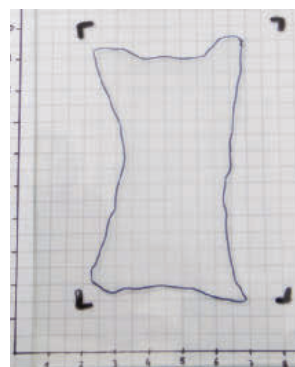
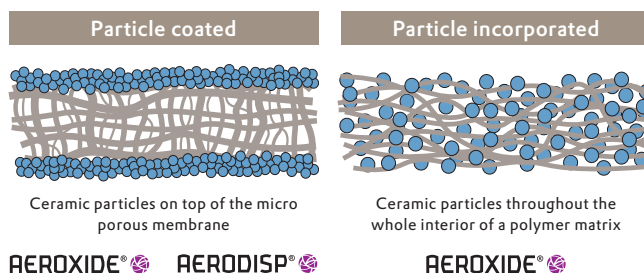

Uncoated separator at 150°C

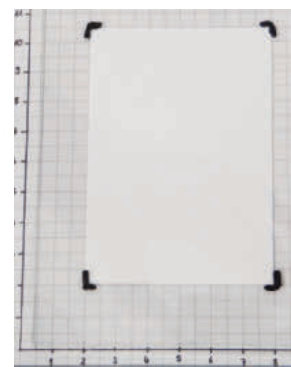

AEROXIDE® coated at 150°C

Silica

# High performance silicon-based powders to boost the storage capacity of batteries



Energy Storage

## Product

Silicon-based powders

## Application

High energy density lithium ion battery anodes

Silicon-based powders from Evonik are designed to provide high energy density and superior performance for lithium ion batteries. The high-performance anode material powders are produced by gas-phase synthesis. The powders consist of separated non-sintered spherical particles with size < 200 nm and are characterized by the amorphous structure.

In addition to our existing products, we develop custom silicon-based anode materials with highly specific requirements.

## Si/C-based composite by Evonik

- Amorphous Si/C structure with unique carbon concentration gradient for superior stability
- Higher surface carbon content beneficial for oxidation protection and improved workability
- High specific capacity > 3,300 mAh/g
- High first cycle efficiency > 90 %
- Typical oxygen content < 1 wt. %
- Variable carbon content

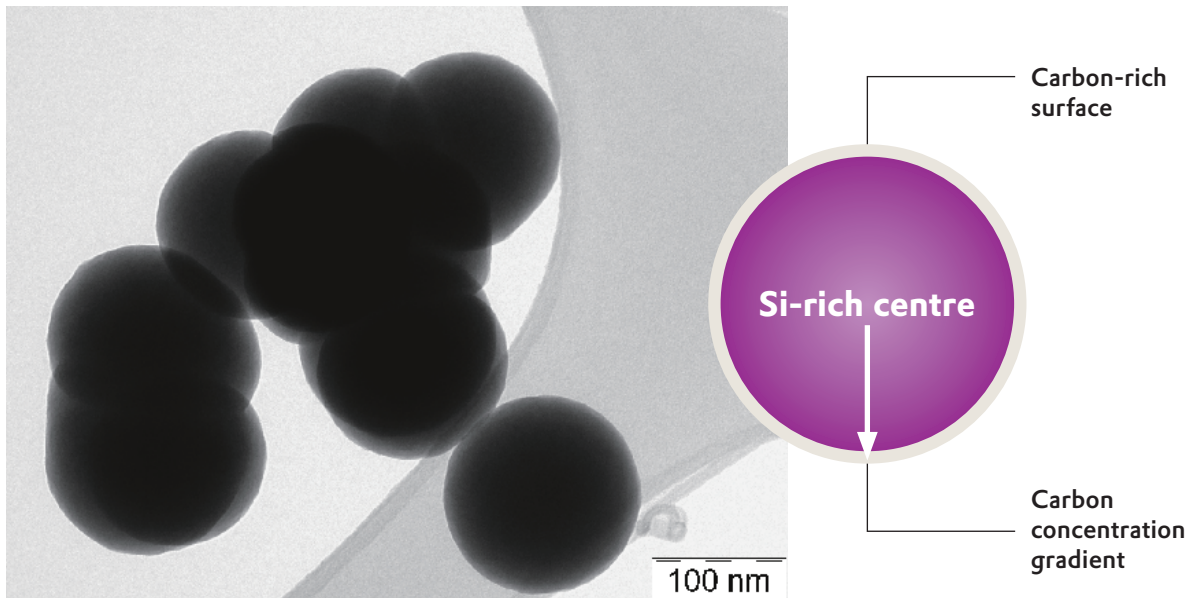

Evonik Si/C composite powders: transmission electron microscopy image (left) and schematic representation of the Si/C structure with carbon concentration gradient (right).

# Process enabler for LIB electrode and separator manufacturing



Energy Storage

Product	Application
Dispersant	Cathode slurry, slurry viscosity reduction, uniform distribution of active materials Cathode slurry, viscosity reduction and uniform distribution of conductive materials
Plasticizer	Electrode, improve electrode layer flexibility and reduce electrode layer cracking
Low foaming, wetting agent	Separator, surface tension reduction for ceramic slurry

The process enablers help contribute to further improvements in the production of LIB's which yield better electrical performance and lower overall costs. Evonik broad surfactant technology platform allow us to offer a wide range of products from wetting and dispersing agents to defoamers as well as plasticizers.

- NMP based dispersant for cathode
- Water based dispersant for anode, separator
- Evonik provides broad wetting technologies
- Evonik provides all types of antifoam

## Applications and key benefits

Separator coating	Wetting agent to ensure uniform coating and adhesive promo
Anode coating	Dispersant for slurry viscosity and grinding time reduction and uniform coating
Cathode coating	Plasticizer as anti-crack and swelling prevention
Electrolyte fillers	Liquid dispersant for next generation solid state electrolyte system
Calendaring	Defoamers to help avoid foaming and air-entrapment

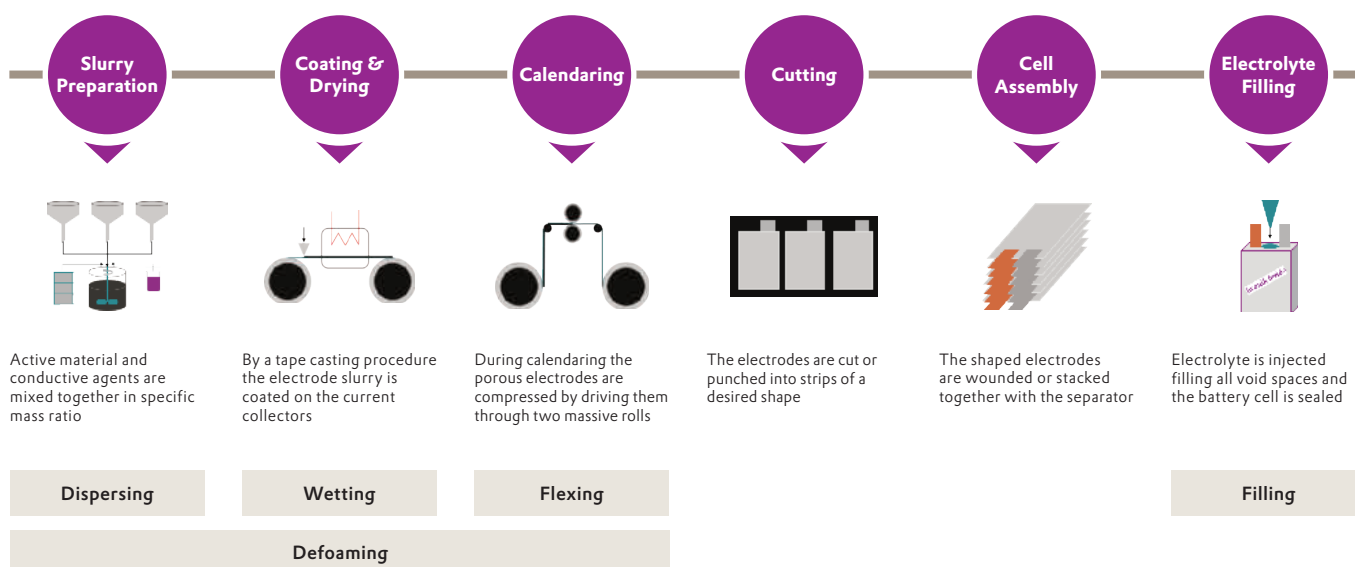

## Interface & Performance



# Insulation for high voltage power busbars with VESTAMID® polyamide 12



Power Management



Efficient management of electric power and permanently effective insulation of electrical components are key elements in e-mobility. The challenges include management of high voltage, high temperatures, and fire protection.

A high level of fire protection is expected of the plastics used over the entire vehicle lifetime. In addition to this fire protection, insulative materials must also have outstanding dielectric properties. This applies particularly to power busbars in high-voltage batteries, which is why these are preferably insulated with polyamide 12 (PA12).

Evonik VESTAMID® PA12 is available at UL fire protection levels and includes halogen-free variants in the portfolio.

Evonik assists customers from setting up parameters for PA12 busbar co-extrusion to the bending of coated busbars and finishing of busbar components. In addition we support with specific polymer testing.

## VESTAMID® for xEV power busbars

Properties	VESTAMID® PA12 compounds
Application voltage	high voltage up to 1000 V, low voltage
Busbar metal core	copper, aluminum, steel, ... (also tin/nickel plated)
Coating material	PA12, various grades available
Coating thickness	0.5 – 1 mm
Coating process	extrusion
Color	orange (RAL2003), natural
Flame resistance acc. UL 94 (IEC 60695-11-10)	V0, V2, HB
Halogen-free	yes
Temperature resistance	-40 to +125°C
Volume resistivity (IEC 62631-3-1)	$10^{13} \Omega\text{m}$
Electric strength (acc. to IEC 60243-2)	> 25 kV/mm
CTI (IEC 60112)	up to 600



# Thermal management with tubing systems from VESTAMID® polyamide 12



Protection & Thermal Management

## xEV battery cooling architectures

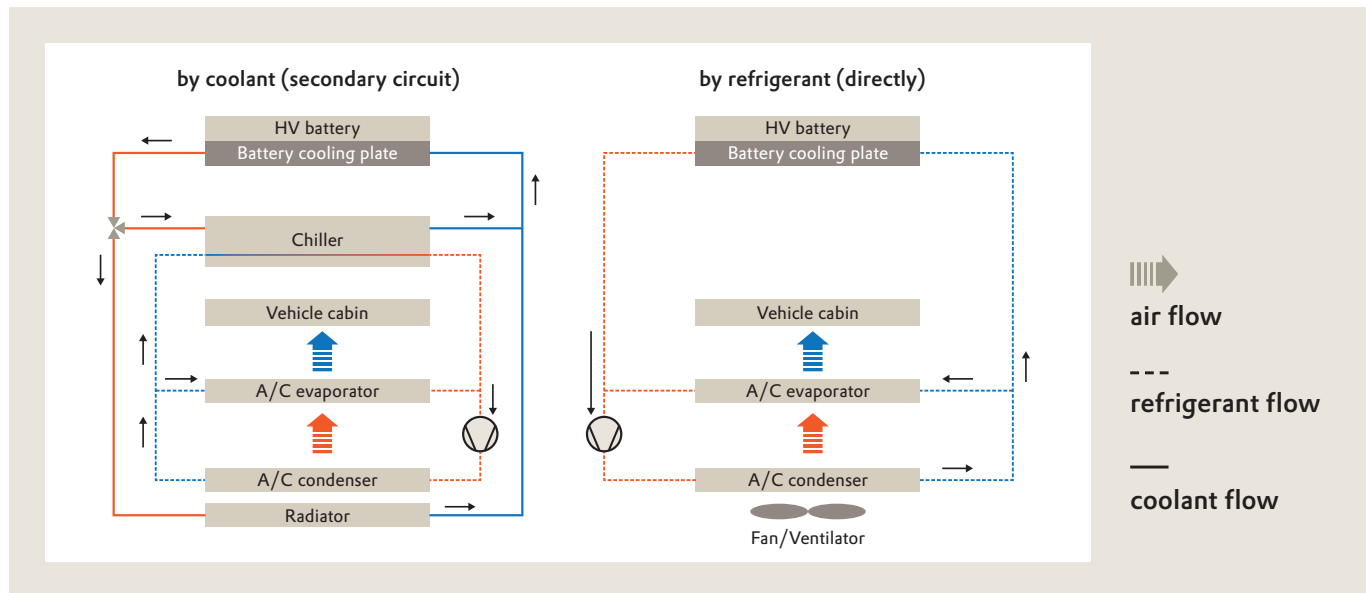

During the high power charging cycles, or while driving (battery discharging), or even while being parked, the temperature of EV battery can exceed the given limit. With lines made from VESTAMID® we provide the suitable solution for both, **water glycol** or **refrigerant** used in the cooling cycle, to enable an effective thermal management and keep the temperature in your car battery at the desired level.

The performance of EV batteries, electric motors, and other high power components benefits from our specialized **mono- and multilayer tubing systems** by keeping its temperatures within the required limits.

### Temperature range

-40°C – 90°C

Monowall tubing systems for BEV

-40°C – 110°C

Monowall tubing systems for PHEV

-40°C – 125°C

Multilayer tubing systems for ICE vehicles



### Evonik cooling line solutions based on VESTAMID®

- Production efficient: Extrusion of MLT, thermoforming and insertion of quick connectors
- Lightweight: 30% to 50% weight reduction of complete system (MLT 8000 vs. AL/rubber)
- Performance: Excellent mechanical and chemical behavior as well as good anti-hydrolysis properties
- System material cost: Significant advantages compared to current concepts
- Packaging benefit: Less package space needed than for rubber hoses
- Excellent performance: Qualified for both, inside and outside battery pack application
- Proven: Serial use at OEMs globally

### High Performance Polymers

# Silicone and filler treatment portfolio for battery assembly



Protection  
& Thermal  
Management

## Silicone portfolio

Product	Application
Polymer VS silicones	Vinyl-terminated silicone portfolio with broad range viscosity starting from 20 mPas
Crosslinkers	Full range with different SiH contents & viscosity
Modifier 705 & 715	Di-function SiH structure to reduce crosslinking density and hardness
VQM 9xx series	Vinyl-functional QM resin for high mechanical properties and transparent formulations
TEGOSIL® Heatban	Heat stabilizer to improve formulation heat resistance up to impressive 300°C
TEGOSIL® FR 1000	Flame retardant co-compound for higher flame retardancy standard

Our full portfolio of silicone raw materials give high flexibility to build your formulation with desired viscosity, curing speed, hardness and high performance. We are willing to offer guiding formulations upon request.



**Evonik solutions include:  
Raw materials and additives for**

- Gap fillers
- Thermally conductive adhesives
- Battery assembly adhesives

## Filler treatment portfolio for better thermal conductivity and flame retardancy

Product	Application
TEGOPREN® 6875 & 6879	Organo-modified siloxane chemistry for hydrophobic treatment of functional filler. Can also be used as in-situ dispersion additive
TEGOMER®	Broad chemical portfolio for filler treatment and in-situ additive in matrix

TEGOPREN® and TEGOMER® products enhance the functionality of different fillers in silicone, urethane, epoxy, acrylic and thermoplastics.

Filler treatment benefits include:

- Improved filler distribution in the matrix to reach better thermal conductivity and flame retardancy
- Reduced formulation viscosity and water uptake
- Further increase of functional filler dosing level which enables even higher performance

For other matrices, we also offer high performance raw materials including NANOPOX®, ALBIFLEX®, ALBIDUR®, for epoxy, NANOCRYL® for acrylic, and more. Please contact us for more information.

### Interface & Performance

# Surfactant and catalyst for polyurethane froth foam as battery pad materials



Protection  
& Thermal  
Management

## Polyurethane froth foam is the ideal EV battery pad material

Battery packs must be protected from shock and vibration to ensure safety and long-term performance. PU froth foam pad is both firm and compressible enough to provide excellent cushioning and vibration absorption in order to extend the life of battery at a broad range of temperatures and harsh working environment.

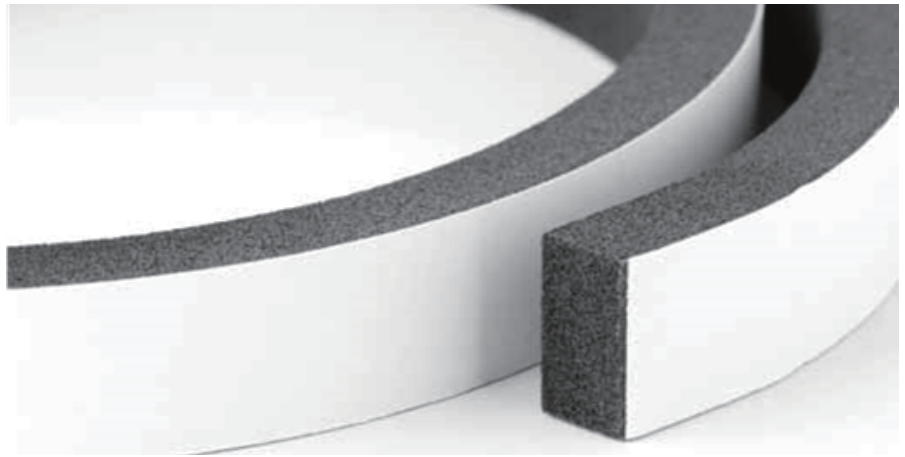

## Polyurethane froth foam is the ideal EV battery pad material

Evonik is the global leader in polyurethane additives. Our extensive product portfolio includes the innovative silicone surfactants and catalysts (amine and metal) needed for successful froth foam systems.

Product	Application
TEGOSTAB® B 8984	Highly potent froth surfactant that provides superior froth stability with a very fine and homogeneous cell structure. Ideally suited for low density froth foams with densities down to 200 kg/m <sup>3</sup> .
TEGOSTAB® B 89120	Low VOC froth surfactant for low density froth foams with densities down to 200 kg/m <sup>3</sup> . Provides superior froth stability with a very fine and homogeneous cell structure. Ideally suited for all polyurethane froth foam applications where VOC is an issue.
TEGOSTAB® B 89177	Froth surfactant for medium and high-density froth foam applications (400 – 800 kg/m <sup>3</sup> ). Can also be used as co-surfactant in combination with TEGOSTAB® B 8984 or TEGOSTAB® B 89120. Free of VOC.
POLYCAT® SA series	Heat activated catalyst with an excellent front-end delay with a wide range of thermo-activation temperatures. By choosing the right catalyst you can help to tailor a delayed reaction to optimize the formulation.

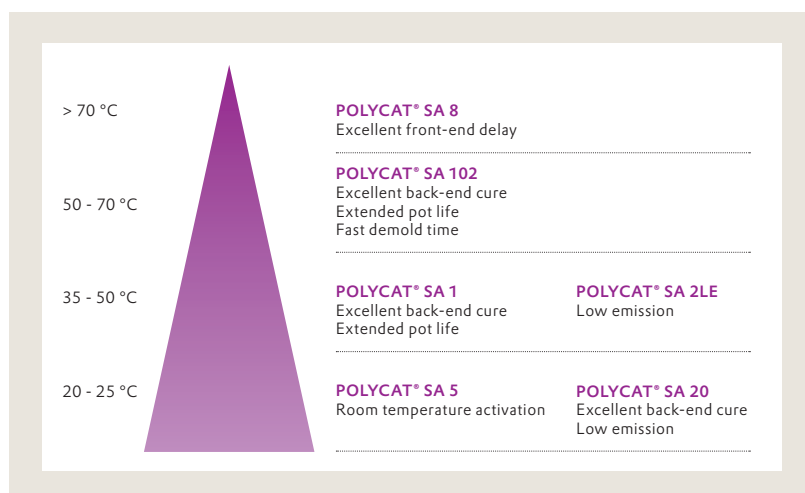

Polyurethane frothing technology requires the addition of unique additives. On the one hand, specially designed surfactants are needed to help stabilize the polyurethane system while also ensuring efficient frothing. These innovative surfactants help to regulate cell size and cell distribution of the foam. On the other hand, delayed action catalysts are required to improve the processing latitudes and process stability. These catalysts ensure that no reaction occurs during the frothing, delivery and final lay-down of the polyurethane mixture. Once the froth is applied, rapid curing is possible under heat.

Comfort & Insulation

# LiB recycling using hydrogen peroxide as eco-friendly reduction agent



Battery Recycling

Product	Application
HYPROX®350, HYPROX®500	Recovery of Li, Co, Ni, Mn in the leaching processes of LiB recovery process;
CLAMARIN®350, CLAMARIN®500	Wastewater treatment to breakdown organics to reduce COD;

Lithium-ion Battery (LiB) is widely used in Electric Vehicles (EV) and smart portable devices, with more and more of them reaching its life expectancy, it is getting more and more critical to recycle the LiB in order to reuse the precious and rare metals (eg. Lithium, Cobalt) as well as addressing the sustainability and environmental protection perspectives.

The global LiB recycling market is expected to grow very fast.

## Application overview

Among the various LiB recycling technology, a commonly widely implemented process is the so-called "Wet Hydrometallurgy" process. In this process hydrogen peroxide ( $H_2O_2$ ) is used as a reduction agent in the leaching process, together with other acids (eg.  $H_2SO_4$ ,  $HCl$  or  $HNO_3$ ) to:

- Transfer all Co(III), Mn(III), Ni(III) to Co(II), Mn(II), Ni(II), allowing better dissolution in the solution;
- Transfer all Fe (II) to Fe (III), allowing easier separation of iron from the solution;
- Increase leaching efficiency and shorten leaching time.

Compared with other reduction agent, hydrogen peroxide decomposes only into water and oxygen, therefore is considered more eco-friendly.

Hydrogen peroxide, with its activated radical group (-OH), can be used alone or in combination with Advanced Oxidation Process (AOP) technologies (eg. Fenton, UV, Ozone), to breakdown organics chains to reduce the COD of waste water.

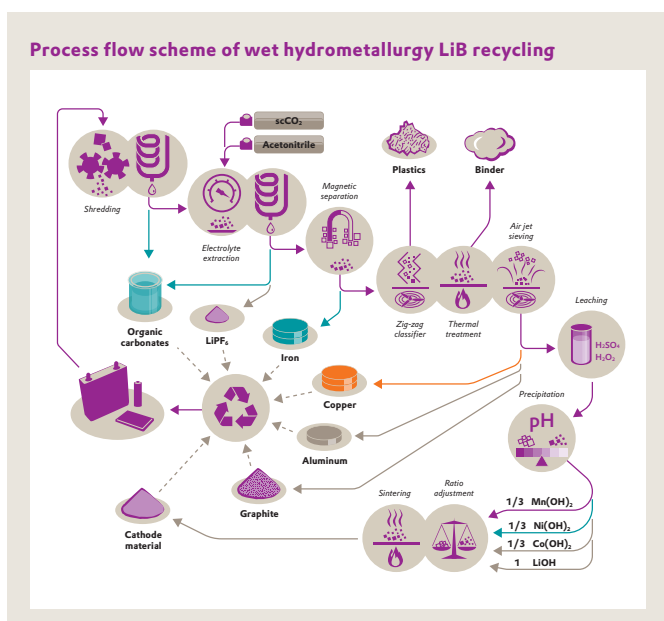

Effect of  $H_2O_2$  on leaching efficiency

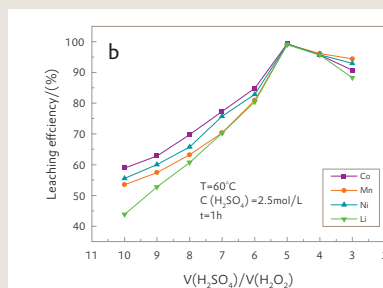

Source: Haiyang Zou, Worcester Polytechnic Institute, Development of a Recycling Process of Li-Ion Batteries

## Evonik offers

- Different grades of hydrogen peroxide used in LiB processes (leaching, water treatment);
- Wide availability of hydrogen peroxide supply from our 13 plants around the world;
- Applied technology and tech services;
- Design, build and inspect  $H_2O_2$  storage tank and dosing units;
- Safety training and handling guideline;



# Your contacts

## Battery Housing Crosslinkers

**EMEA**  
+49 2365 49 5981  
leif.ickert@evonik.com

[www.vestalite.com](http://www.vestalite.com)

**ASIA**  
+86 21 6119-1348  
martin.lei@evonik.com

**Americas**  
+1-862-309-3518  
steffen.kanzler@evonik.com

## Energy Storage Silica

**EMEA**  
+49 6181 59 13292  
reinhard.vormberg@evonik.com

+49 6181 59 2533  
daniel.esken@evonik.com

[www.silica-specialist.com](http://www.silica-specialist.com)

**ASIA**  
+86 21 6119-1656  
eunjoo.lee@evonik.com

+886 2 2175-5299  
yc.huang@evonik.com

**Americas**  
+1-732-354-5372  
matthew.linares@evonik.com

+1-732-981-5328  
victor.lifton@evonik.com

## Silane

**EMEA**  
+49 6181 59 13234  
bjoern.borup@evonik.com

+49 6181 59 6838  
julia.lyubina@evonik.com

**ASIA**  
+86 21 6119-3850  
whei-noon.hsu@evonik.com

+886 2 2175-5247  
jack.chen@evonik.com

**Americas**  
+1-973-929-8661  
tiffany.grant@evonik.com

## Interface & Performance

**EMEA**  
+49 201 173-3090  
benjamin.brehmer@evonik.com

+49 201 173-3177  
pierfrancesco.caponi@evonik.com

**ASIA**  
+86 21 6119-1122  
cj.mu@evonik.com

+86 21 6119-3037  
raymond.gong@evonik.com

**Americas**  
+1-804-727-0679  
kai.wirz@evonik.com

## Power Management High Performance Polymers

**EMEA**  
+49 2365 49 9209  
eckart.ruban@evonik.com

**ASIA**  
+86 21 6119-3744  
zackary.shi@evonik.com

**Americas**  
+1-567-295-9842  
jeffery.beach@evonik.com

## Protection & Thermal Management High Performance Polymers

**EMEA**  
+49 2365 49 9209  
eckart.ruban@evonik.com

**ASIA**  
+86 21 6119-3744  
zackary.shi@evonik.com

**Americas**  
+1-567-295-9842  
jeffery.beach@evonik.com

## Interface & Performance

**EMEA**  
+49 201 173-2095  
peter.seidensticker@evonik.com

**ASIA**  
+86 21 6119-3263  
mary.luo@evonik.com

**Americas**  
+1-804-727-0639  
alexandra.fersner@evonik.com

## Comfort & Insulation

**EMEA**  
+49 201 173-2745  
julien.couet@evonik.com

**ASIA**  
+86 21 6119-3653  
zheng.zhu@evonik.com

**Americas**  
+1-610-573-5231  
erica.lee@evonik.com

## Battery Recycling Active Oxygens

**EMEA**  
+49-618159-12439  
christoph.batz-sohn@evonik.com

**ASIA**  
+82-2-320-4742  
changyong.oh@evonik.com

**Americas**  
+1-973-929-8135  
florian.lyon@evonik.com



## **Evonik Operations GmbH**

Rellinghauser Straße 1–11  
45128 Essen, Germany

Evonik Specialty Chemicals (Shanghai) Co.,  
Ltd. 55 Chundong Road, Shanghai, China  
PHONE +86 21 6119-1000

Evonik Corporation  
Parsippany, NJ 07054, United States  
PHONE +1 973 929-8000

[www.evonik.com](http://www.evonik.com)  
[automotive.evonik.com](http://automotive.evonik.com)

AEROXIDE®, AERODISP®,  
CLARMARIN®, HYPROX®,  
POLYCAT®, TEGOSIL®,  
TEGOSTAB®, TEGO® Surten,  
VESTALITE®, VESTAMID®,  
VISIONER® are registered  
trademarks of Evonik Industries AG  
or its subsidiaries.

This knowledge and all further technical advice is based on our present knowledge and experience. However, it implies no liability or other legal responsibilities on our part, including with regard to existing third party intellectual property rights, especially patent rights. In particular, no warranty, whether express or implied, or guarantee of product properties in the legal sense is intended or implied. We reserve the right to make any changes according to technological progress or further developments.

The customer is not released from the obligation to conduct careful inspections and testing of incoming goods. Performance of the product described herein should be verified by testing, which should be carried out only by qualified experts in the sole responsibility of a customer. Reference to trade names used by other companies is neither a recommendation, nor does it imply that similar products could not be used.